

5 OPENER PROGRAMMING & ACCESSORY INSTALLATIONS

NOTE: Before programming the opener, check to make sure there are no objects in the garage door opening. DO NOT allow persons to enter the area of the door while programming and operating.

The following steps list the order of programming the opener's functional settings as well as installation of any accessories that were included with the opener or purchased separately. **These steps should be performed in order.**

1. Adjust opener speed for drum sizes.
2. Down Travel Limit
3. Up Travel Limit
4. Force Control
5. Contact Reverse test and adjustment
6. Remote Control Programming
7. Remote control(s), Lighting fixture and Wireless Wall Console included with this opener are programmed at the factory. The information provided on these pages should be used if adding additional remote controls, wireless wall consoles or light fixtures.
8. Accessory Installation and/or Programming
9. Program wireless keypad (If applicable)
10. Program built in vehicle remote (If applicable)
11. Program the Integrated Aladdin Connect™ (If applicable)
12. Install Battery Backup (BBU) (If applicable)

NOTE: When opener is activated to close, opener will start and stop slowly in small increments to detect cable tension then run at normal speed to close. This is normal operation.

Programming Button Layout

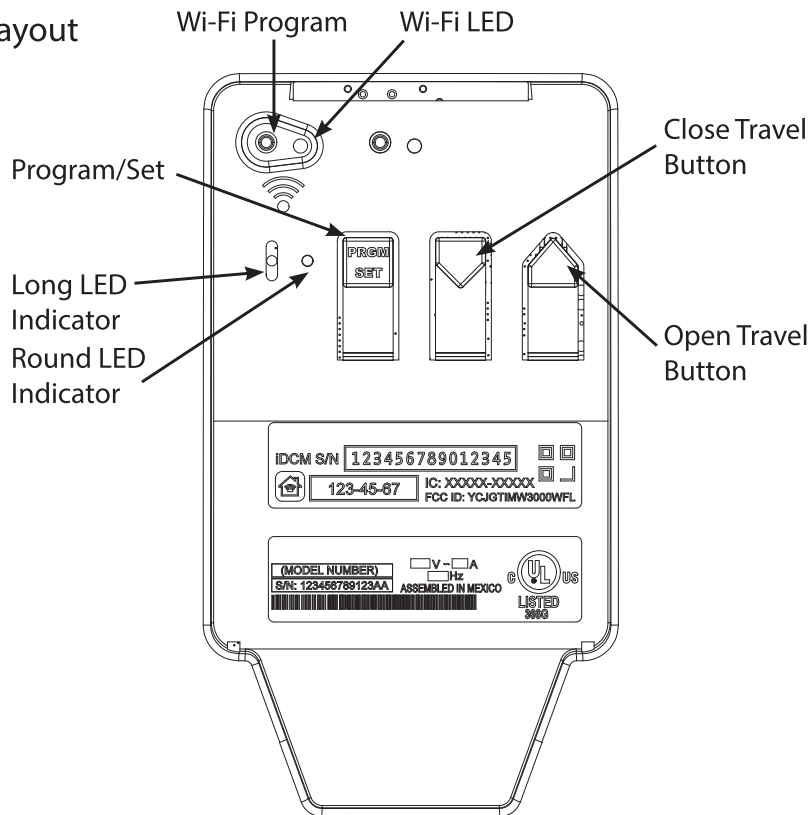

NOTE: Each programming step has a 30 second time limit for completion after the function is initiated. After 30 seconds, both LED's will illuminate RED indicating time has expired and the step must be restarted. Restart the step as many times as necessary to complete the programming.

ADJUSTING FOR DRUM SELECTION

⚠ WARNING

Operator drum selection settings must be adjusted for use on Standard or High Lift residential doors with drum diameters greater than 4 inches. Drum selection settings must also be adjusted for use on residential Vertical Lift doors.

⚠ AVERTISSEMENT

Les réglages de sélection du tambour par l'opérateur doivent être ajustés pour une utilisation sur des portes résidentielles à levage régulier ou élevé avec des diamètres de tambour supérieurs à 4 pouces (10,16 cm). Les réglages de sélection du tambour doivent également être ajustés pour une utilisation sur des portes résidentielles à levage vertical.

Drum Selection Settings

Drum selection settings are pre-programmed at the factory for 4" Standard Lift type drums. Drum selection must be made on doors with Standard or High Lift drums with a diameter greater than 4 inches, and also on Vertical Lift doors. There are two drum settings available for sectional doors. Please note that door speed may be affected by door weight, drum type, and balance, along with condition of door components and tracks. Proper selection of the drum type is important for proper operation of the opener.

TO CHANGE OPENER drum selection:

1. Press and hold the SET/PRGM button on the opener until both LEDs turn BLUE then release.
2. Press the UP button twice.
3. Press PRGM button once.
4. The current setting will now be displayed. (SEE CHART).
5. Press either UP or DOWN buttons to adjust setting (SEE CHART)
6. Press PGRM button once to lock in the selection. LEDs turn BLUE then off.
7. Opener is now ready to set limits.

⚠ IMPORTANT NOTICE ⚠

IF DRUM SELECTION SETTING IS ALTERED, ALL FOLLOWING STEPS ON PAGES 18 THROUGH 20 MUST BE PERFORMED TO LOCK IN THE FORCE PROFILE FOR PROPER DOOR OPERATION.

DRUM SELECTION CHART

DRUM TYPE	Long LED	Round LED
Standard 4 inch or less diameter drum	RED	RED
Standard or High Lift greater than 4 inch diameter or Vertical Lift	PURPLE	PURPLE

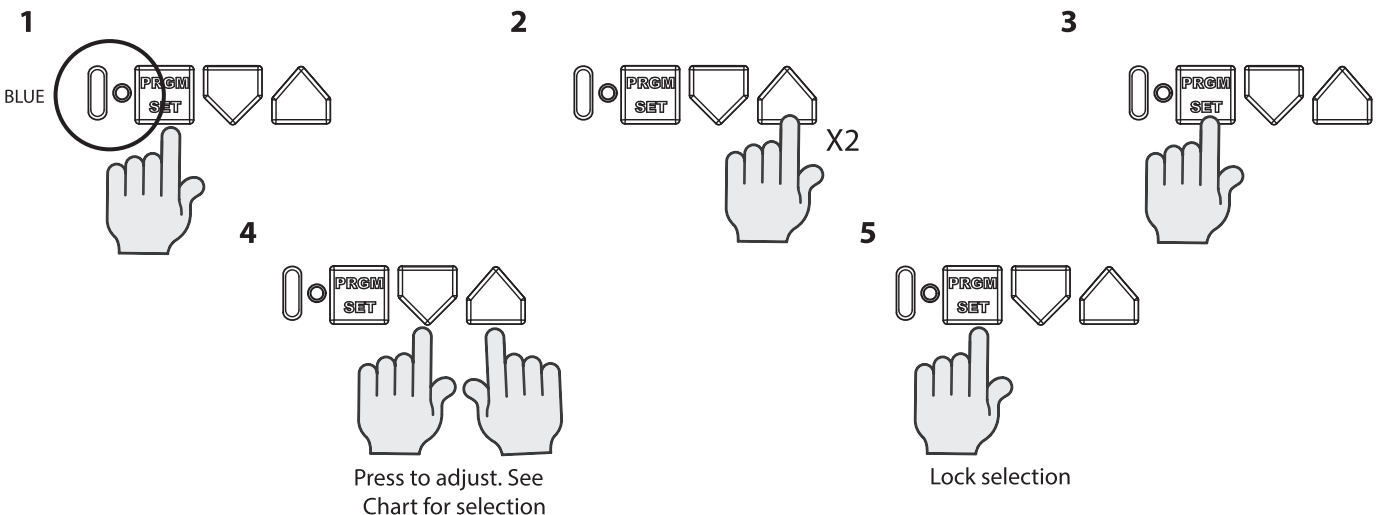

PROGRAMMING THE DOWN LIMIT

⚠ WARNING

- Make sure doorway is in full view and clear of obstacles and people to avoid injury or property damage.
- DO NOT operate this unit from the wall control before LIMITS are set. Severe damage to the opener could occur.
- DO NOT set limits with Battery Backup attached. AC power MUST be connected to the opener while setting limits for proper operation.

⚠ NOTE: Door MUST be engaged to the opener prior to programming. Door should rest somewhere between full open and closed. **DO NOT START WITH DOOR FULLY OPEN OR CLOSED.**

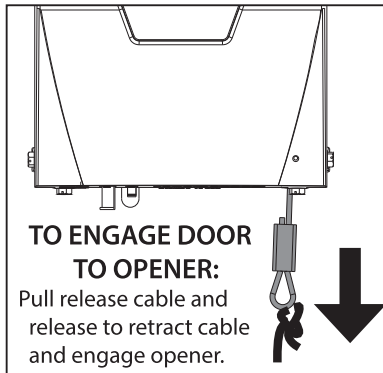

Programming DOWN Limit:

1. Press and hold the DOWN arrow button on the opener for 2-5 seconds.
 - The LONG LED will turn BLUE. Release button.
 - The LONG LED will then flash BLUE.
2. Press and hold the DOWN arrow button until door is fully closed.
Use both UP and DOWN buttons to adjust close travel as necessary.

Door should rest on the floor until the weather strip is compressed enough to seal along the width of the door. Damaged doors or uneven floors may not seal properly. Repair these conditions to achieve a proper seal. DO NOT compress seal so much that the door will bend or buckle.

3. Press and release the SET/PRGM button
Both LEDs will flash BLUE then go out.

The DOWN limit is now programmed.

⚠ AVERTISSEMENT

- S'assurer que le passage de la porte est visible et dégagé, à savoir sans obstacles ni personne afin d'éviter toute blessure potentielle ou dommage matériel.
- NE PAS utiliser cette unité avec la console murale avant d'avoir réglé les LIMITES. L'ouvre-porte pourrait subir de sérieux dommages.
- NE PAS fixer de limites en mode batterie de secours. L'alimentation CA DOIT être branchée sur l'ouvre-porte, pendant le réglage des limites, pour assurer un bon fonctionnement.

1-2. Enter Programming Mode

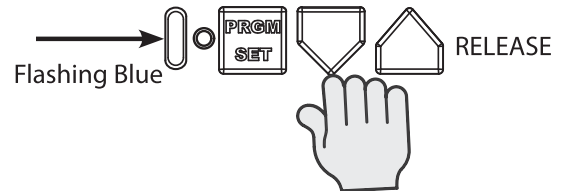
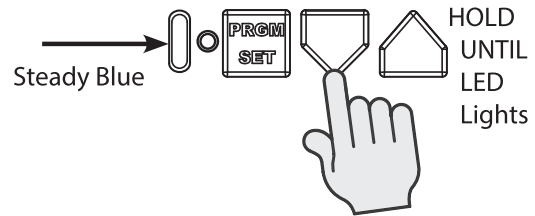

3. Adjust Door Position

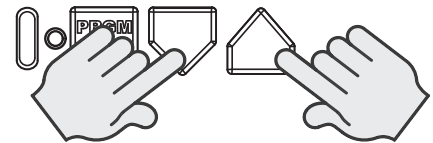

4. Lock Programming

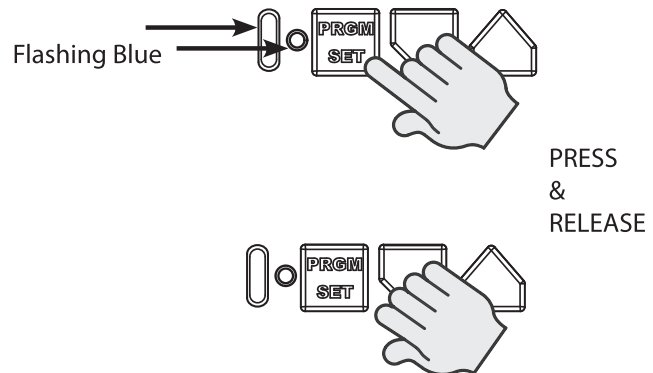

⚠ IMPORTANT NOTICE ⚠

IF DOWN LIMIT SETTING IS ALTERED, ALL FOLLOWING STEPS ON PAGES 19 THROUGH 20 MUST BE PERFORMED TO LOCK IN THE FORCE PROFILE FOR PROPER DOOR OPERATION.

PROGRAMMING THE UP LIMIT

Programming UP Limit:

1. Press and hold the UP arrow button on the opener for 2-5 seconds.
 - The LONG LED will turn BLUE. Release button.
 - The ROUND LED will then flash BLUE.
2. Press and hold the UP arrow button until door is fully open. Use both UP and DOWN buttons to adjust open travel as necessary.
3. Press and release the SET/PRGM button. Both LEDs will flash BLUE then go out.

SECTIONAL DOOR UP LIMIT:

Door should fully open so that door seal is about even with door header. Do not adjust so much that the door will bend, buckle or stretch door spring cables backward.

The UP limit is now programmed.

1-2. Enter Programming Mode

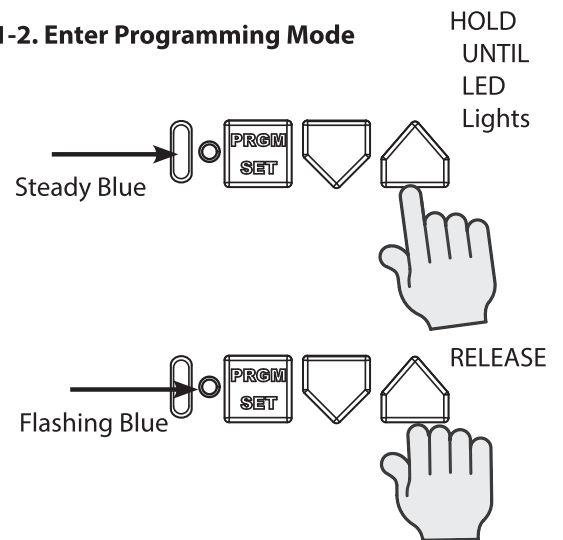

3. Adjust Door Position

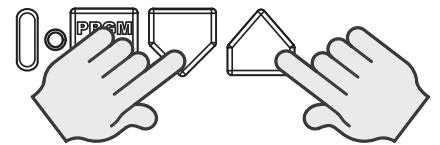

4. Lock Programming

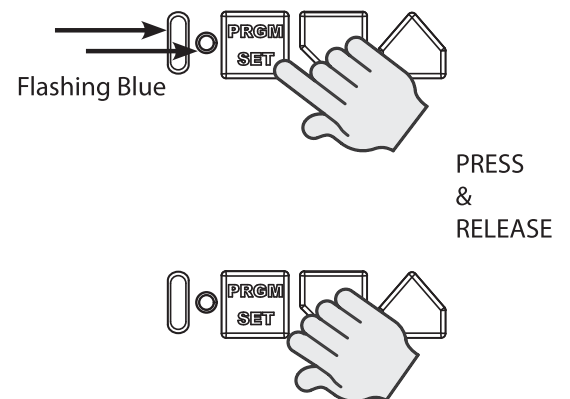

! IMPORTANT NOTICE !

IF UP LIMIT SETTING IS ALTERED, ALL FOLLOWING STEPS ON PAGE 20 MUST BE PERFORMED TO LOCK IN THE FORCE PROFILE FOR PROPER DOOR OPERATION.

PROGRAMMING FORCE PROFILE & CONTACT REVERSE

⚠ IMPORTANT NOTICE ⚠

THIS STEP MUST BE PERFORMED FOR PROPER OPERATION!

- Operate opener 2 full cycles up and down to set new opener profile.

⚠ WARNING

TO AVOID INJURY OR DAMAGE

NEVER adjust the force settings to adjust for damage, including an unbalanced door, binding door track or broken spring.
Perform a CONTACT REVERSE TEST monthly.

⚠ AVERTISSEMENT

Pour éviter les blessures ou des dommages

NE JAMAIS régler la force pour compenser des dommages, y compris une porte mal équilibrée, un rail de porte coincant ou des ressorts cassés.
Tous les mois, EFFECTUEZ LE TEST D'INVERSION AU CONTACT.

SETTING FORCE PROFILE

1. Press and release the Wall Control button and allow the garage door to travel and stop at the DOWN limit.
2. Press and release the wall control button and allow the garage door to travel and stop at the UP limit.
3. Repeat steps 1 and 2 to complete this setting.

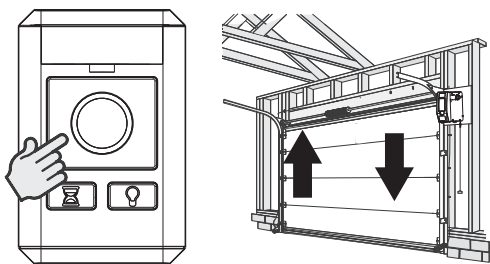

Force Control Adjustments

Force settings are programmed from the factory to remain within safe parameters. These should not require adjustments. However, certain circumstances may require adjustment.

Refer to page 27 to adjust the force settings.

Contact Reverse Test

NOTE: The limit and Force settings **MUST BE COMPLETED** before performing the Contact Reverse Test.

1. With the garage door open, lay a 2 X 4 board flat on the floor at the center of the door opening.
2. Close the garage door using the wall control.

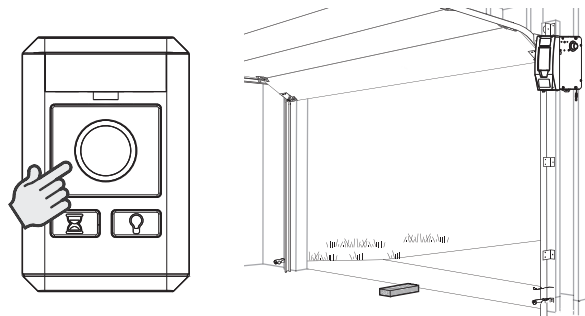

- When the door contacts the board, it should stop and reverse direction within 2 seconds to the full open position.
- The long LED light on the powerhead will begin to flash RED with the reversal of the door.
- Remove the 2" x 4" board and operate the opener with the wall control again. This cycle will clear the flashing red LEDs.

Contact Reverse Adjustment

If the door stops before contacting the board or if it does not reverse direction to fully open after contact with the board, it may be due to an improperly set DOWN limit. Verify settings by:

1. Repeat "Programming the Down Limit" section to make certain the door is closing tight against the floor.
2. Repeat the "Force Control" section on the left to set force limits.
3. Repeat the "Contact Reverse Test" above.

Repeat this process as needed until the door passes the Contact Reverse Test.

Refer to page 27 to adjust the force settings.

PROGRAMMING ADDITIONAL REMOTE CONTROLS

THE REMOTE CONTROLS INCLUDED WITH THIS OPENER HAVE BEEN PROGRAMMED AT THE FACTORY FOR YOUR CONVENIENCE.

NOTE: The following instructions are for remote control transmitters purchased separately (In addition to those provided with this opener) but can also be used if remote(s) require re-programming.

NOTE: Each programming step has a 30 second time limit for completion after the function is initiated. After 30 seconds, two LED's will illuminate RED indicating time has expired and the step must be re-started. Restart the step as many times as necessary to complete the programming.

NOTE: Each button on each remote must be programmed separately, following these steps.

1. Remove the battery's protective film from the remote by pulling straight down.
2. Press and hold the SET/PRGM button on the opener for 2-5 seconds.
 - The ROUND LED will turn BLUE. Release button.
 - The LONG LED will then flash PURPLE.
3. Stand at least 5 feet away from opener and slowly press and release the desired button on the remote two times.
Both opener LEDs will flash and turn off indicating the remote has been programmed.
4. Press the desired remote button again.
The opener should run.

To program the same remote for other garage door openers, repeat the steps above using one of the other remaining remote buttons.

REPEAT STEPS 1 TO 4 FOR EACH OPENER AND REMOTE

NOTE: It is possible to press the remote button too quickly or lightly. If the LEDs do not go off, press the remote button several more times to achieve confirmation.

BASIC PROGRAMMING IS COMPLETE AND YOUR GARAGE DOOR OPENER IS READY TO USE.

See page 28 of this manual to erase remote devices from memory.

1. Activate Remote



2. Enter Programming Mode

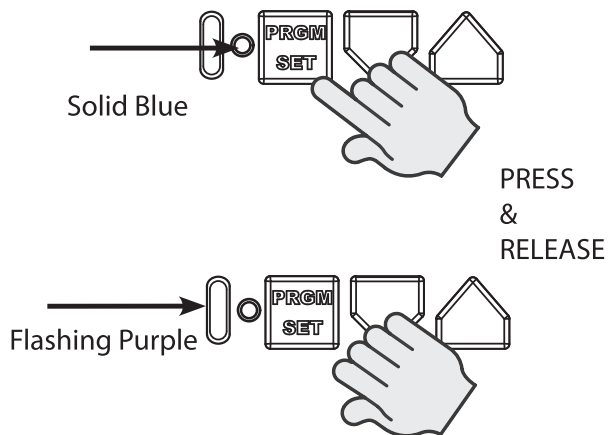

3. Press Remote Button Twice

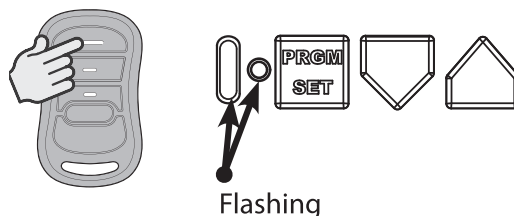

4. Test Remote

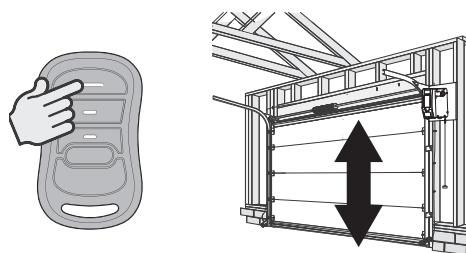

PROGRAMMING ACCESSORIES (ABBREVIATED)

QuickView Single Door setup.

Please see complete instructions that accompany keypad

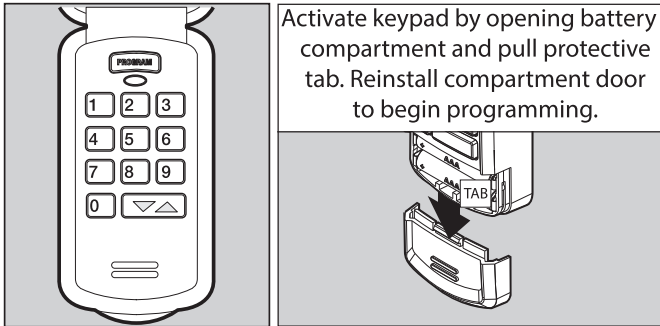

Program Keypad before mounting.

STEP 1) PROGRAMMING A PIN NUMBER (Single Door)

Program the keypad for the first time* with a Personal Identification Number (PIN). This PIN must be 3 to 8 digits.

1. Ensure number pad back lighting is off.
2. Press 3-5-7 in sequence.
3. Press PROGRAM key. *LED will blink once per second.*
4. Enter a PIN number (3-8 digits).
5. Press PROGRAM key. *LED will blink twice and shut off.*

STEP 2) PROGRAMMING THE KEYPAD TO 1 OPENER

1. Place garage door opener into PROGRAMMING MODE.
2. Ensure number pad back lighting is off.
3. Enter the PIN number on keypad.
4. Press the UP/DOWN key 3 to 4 times slowly until garage door opener operates.

PUTTING OPENER INTO PROGRAMMING MODE:

1. Press and hold the SET/PRGM button on the opener for 2-5 seconds.
 - The ROUND LED will turn BLUE. Release button.
 - The LONG LED will then flash PURPLE.
2. Complete programming steps.

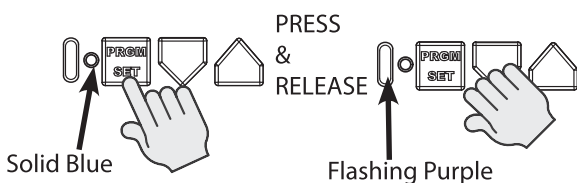

NOTE: The openers LEARN LED will time out in 30 seconds. Programming must be completed within 30 seconds.

STEP 3) OPERATING THE KEYPAD WITH THE OPENER

Single Door Operation:

1. Ensure number pad back lighting is off.
2. Enter PIN number.
3. Press the UP/DOWN key.
4. Opener will operate.

NOTE: Keypad will remain active for 15 seconds after a successful entry is made. During this 15 seconds ANY key will operate the opener.

Resetting a PIN:

Press and hold both the **PROGRAM** key and the Up/Down key for about five seconds.

The LED's will slowly blink and then go out. When the LED stops blinking, the old programming has been successfully erased.

To create a new PIN go to STEP 1-Programming a PIN number.

Mounting Keypad

The keypad **MUST** be mounted within sight of the garage door(s) at least five feet above the floor and clear of any moving door part.

1. Remove battery cover and batteries.
2. Drill 3/32" pilot hole for the top mounting screw (included).

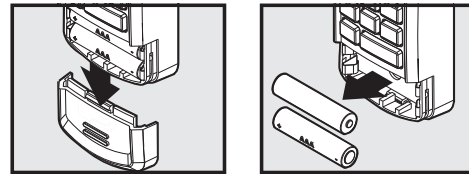

3. Install a screw into the pilot hole, leaving a 1/8" gap between the screw head and wall.
4. Hook the slotted mount, on back of keypad, over the screw.

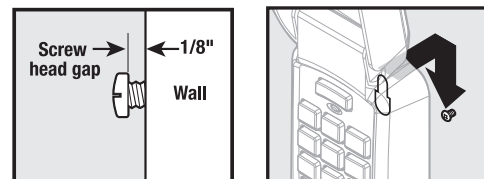

5. Mark and drill a pilot hole for the bottom screw (included)

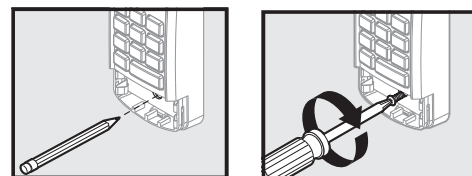

- and secure keypad to wall (DO NOT overtighten).
6. Reinstall batteries and cover.

PROGRAMMING VEHICLE CONTROLS (ABBREVIATED)

Programming HomeLink® System

Step 1 Clear HomeLink

Clear HomeLink by pressing and holding down the first and third buttons until the indicator on the HomeLink blinks slow and then fast for 22 seconds; then release both buttons.

NOTE: Clearing the HomeLink will remove all previously programmed garage door openers.

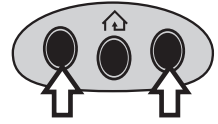

Step 2 Train HomeLink to the Remote

Choose the button on the HomeLink that will be used to open the door.

NOTE: Hold the Remote two inches from the HomeLink button.

Hold down the remote button. While holding, press and hold the chosen HomeLink button.

Hold down both buttons until the indicator on the HomeLink blinks slow then fast. Once it blinks, release both buttons.

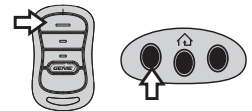

Step 3 Program HomeLink to the Opener

(Place opener into programming mode)

A. Press and hold the **PRGM** button on the opener until the round blue LED is ON. Release the button. The long purple LED will begin flashing.

PUTTING OPENER INTO PROGRAMMING MODE:

1. Press and hold the SET/PRGM button on the opener for 2-5 seconds.
 - The ROUND LED will turn BLUE. Release button.
 - The LONG LED will then flash PURPLE.
2. Complete programming steps.

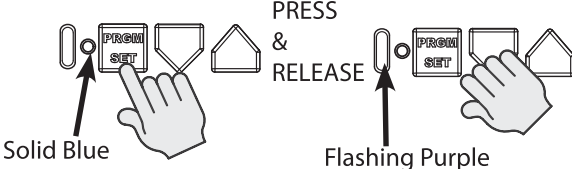

NOTE: The openers LEARN LED will time out in 30 seconds. Programming must be completed within 30 seconds.

B. Press the chosen HomeLink button for two seconds and release. Press that same button again for two seconds and release. The both LEDs will flash blue and then turn off.

C. Press the HomeLink button a few more times until door moves.

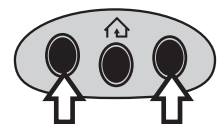

NOTE: For additional instructions, see the motor vehicle manual, www.homelink.com or visit www.geniecompany.com

PROGRAMMING VEHICLE CONTROLS (ABBREVIATED)

Programming Car2U[®] System

Step 1 Clear Car2U to default settings

The default setting for the Car2U system is:

- Button 1 = Overhead Door™ & Genie® Manufactured Openers
- Button 2 = LiftMaster® Manufactured Openers
- Button 3 = Wayne Dalton® Manufactured Openers

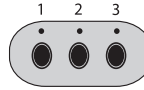

- A. Press and hold buttons 1 and 3 for 22 seconds or until all three LEDs begin to flash.
- B. Release both buttons. The Car2U system is now set to the Factory Default settings

NOTE: Clearing the Car2U remote will remove all previously programmed garage door openers.

Step 2 Program Car2U to the Opener (Place opener into programming mode)

- A. Press and hold the **PROGRAM** button on the opener until the round blue LED is ON—release the button. The long purple LED will begin flashing.
- B. Press the designated Car2U button for two seconds and release. Press that same button again for two seconds and release. The long LED will flash blue and then turn off.
- C. Press the Car2U button a few times more until door moves.

PUTTING OPENER INTO PROGRAMMING MODE:

1. Press and hold the SET/PRGM button on the opener for 2-5 seconds.
 - The ROUND LED will turn BLUE. Release button.
 - The LONG LED will then flash PURPLE.
2. Complete programming steps.

A diagram illustrating the programming process. On the left, a hand presses a button labeled 'PRGM SET' on a remote. An arrow points to a 'Solid Blue' LED. In the center, the text 'PRESS & RELEASE' is shown above a hand releasing the button. On the right, an arrow points to a 'Flashing Purple' LED. The remote also shows icons for a house and a car.

NOTE: The openers LEARN LED will time out in 30 seconds. Programming must be completed within 30 seconds.

Step 3 Changing Factory Default Button for a Genie® or Overhead Door™ Opener

- A. Press and hold buttons 1 & 3 for **ONE SECOND** and release all three LEDs will light solid red.
- B. Press and hold the button (2 or 3) to change it to a **Genie® or Overhead Door™ Opener**, corresponding LED will flash. While continuing to hold that button, press and release button 1. Press and release button 1 again.
- C. Release the button being held in step B and wait for the LED to stop flashing. This button is now set. Repeat Step 2 for second Opener.

PROGRAMMING ALADDIN CONNECT™

NOTICE: The Aladdin Connect® feature will NOT operate unless the light fixture is installed and operational.

Perform these steps only after opener and light fixture are fully installed, programmed and tested.

IMPORTANT SAFETY INSTRUCTIONS

WARNING

TO REDUCE THE RISK OF SEVERE INJURY OR DEATH, READ AND FOLLOW ALL INSTRUCTIONS.

1. Never allow children to operate or play with door controls.
2. Install the entrapment WARNING placard next to the wall control in a prominent location.
3. NO PERSONS SHOULD CROSS THE PATH OF A MOVING DOOR.
4. NEVER GO UNDER A STOPPED/PARTIALLY OPEN DOOR.
5. The Aladdin Connect™ operating system is designed for unattended operation. The door could move unexpectedly.

SAVE THESE INSTRUCTIONS

CONSIGNES DE SÉCURITÉ IMPORTANTES

AVERTISSEMENT

POUR RÉDUIRE LE RISQUE DE BLESSURES GRAVES VOIRE MORTELLES, LIRE ET COMPRENDRE TOUTES LES INSTRUCTIONS.

1. NE JAMAIS laisser les enfants utiliser ou jouer avec les commandes de l'ouvre-porte.
2. Placer l'étiquette d'AVERTISSEMENT en cas de coincé à proximité du bouton mural ou de la console murale de manière à ce qu'elle soit bien en évidence.
3. NE JAMAIS PASSER SOUS LA PORTE EN MOUVEMENT.
4. NE JAMAIS PASSER SOUS UNE PORTE À L'ARRÊT PARTIELLEMENT OUVERTE.
5. Le système d'exploitation Aladdin Connect™ a été conçu pour fonctionner sans surveillance. La porte peut se déplacer de façon inattendue.

CONSERVER CES INSTRUCTIONS

Integrated Aladdin Connect™

The Aladdin Connect™ system is a convenient mobile device app to operate up to 20 garage door openers/controllers from Aladdin Connect™.

The Aladdin Connect™ app has the following features:

Up to 20 users for each account.

Sends notifications any time the garage door is operated from the app, wall console or remote control.

Show reports for opener usage showing dates and times when the opener was operated.

Show reports of who operated the opener when used from another user on the account.

Set custom RULES for predetermined times to automatically close a chosen door and/or notify of its operation.

Opener light system and an audible signal will activate as a warning that the opener is about to operate.



To use the Genie® Aladdin Connect™ app to control this garage door system follow these steps.

Other home automation apps may also control this garage door opener system. Check our website at www.geniecompany.com for updates pertaining to compatible 3rd party apps.

1 Check Wi-Fi Signal

FOR ALL APPS - Use smart phone or other mobile device to check Wi-Fi signal strength.

Hold the device near the garage door opener and check Wi-Fi meter on the device.

If signal is present, proceed to step 2 if using the Aladdin Connect™ app.

Follow manufacturers instructions for other 3rd party apps.

If signal is very weak or nonexistent, try the following:

Move Wi-Fi router closer to the garage.

Install a Wi-Fi range extender.

(Available at most electronics stores.)



2 Download the Aladdin Connect™ app (Unless using 3rd party app)

Scan for iOS app
Versions 8 and higher



Apple and the Apple logo are trademarks of Apple Inc., registered in the U.S. and other countries. App Store is a service mark of Apple Inc.

Scan for Android app
Versions 4.4 and higher



3 Follow the Aladdin Connect™ app instructions

Follow steps per the app instructions.

- Create an account
- Set up opener(s)
- Add users
- Set rules and notifications.

For help at any time contact The Genie Company at 1-866-599-4995 or visit our website.
www.geniecompany.com

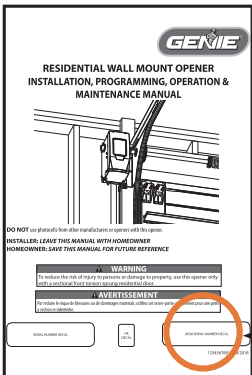

Scan the Aladdin Connect™ QR Code on the front of this manual or on the powerhead when prompted by the Aladdin Connect™ app.

4 Install WARNING placard

Place included unintended operation warning placard next to garage door openers wall button.

NOTE: This placard should be used in lieu of the standard WARNING placard included with this opener.



NOTE: Use of this product, the software embedded within this product and the related application software is subject to the Terms and Conditions available at: www.geniecompany.com